

Wireless Colorimeter and Turbidity Sensor

PS-3215

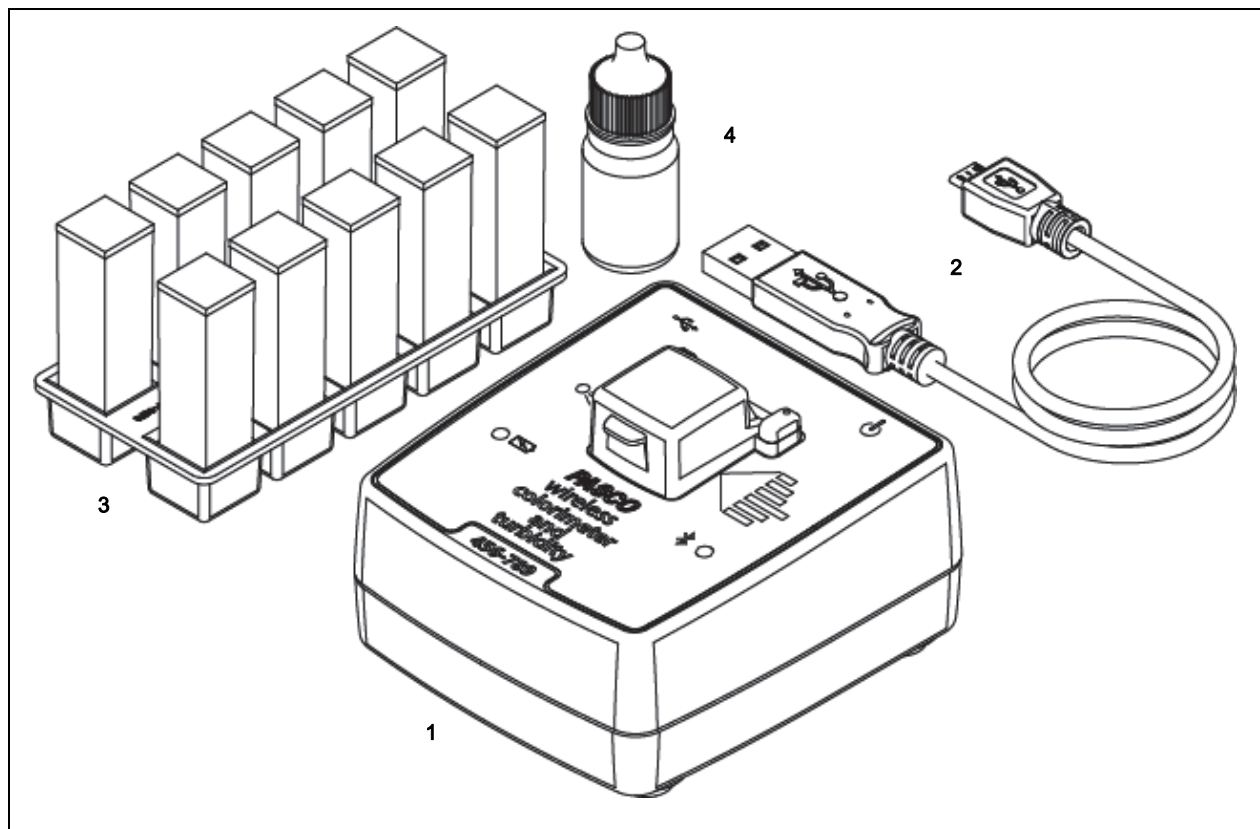

Included Equipment	Item	Included Equipment	Item
Wireless Colorimeter and Turbidity Sensor	1	USB-to-Micro-USB Cable	2
Cuvettes and Cuvette Holder	3	100 NTU Calibration Solution Bottle	4
Calibration Cuvette Label (not shown)			

Introduction

This Wireless Colorimeter and Turbidity Sensor is a versatile instrument that measures absorbance and transmittance of six color wavelengths through solutions using a sensing element that detects six wavelengths. The sensor makes twelve measurements: absorbance and transmittance of red, orange, yellow, green, blue and violet light. These measure-

ments can be used to determine a solution's concentration. These measurements can be used to approximate a solution's visible light spectrum, determine its concentration and observe a reaction.

The sensor can also measure the turbidity level (cloudiness) of water samples in nephelometric turbidity units (NTU) by measuring light scattered by the sample at 90 degrees. The light source is stabilized to prevent drift.

The Turbidity Sensor makes relative measurements of turbid solutions with a particle size between 0 and 200 microns. Because turbidity is a time-dependent dynamics phenomenon, factors such as particle density, particle size, temperature, and pressure may cause reading variation, especially in repeatability studies.

The sensor's opaque housing eliminates ambient light.

NOTE: The Wireless Colorimeter and Turbidity Sensor is designed for educational use only and is not recom-

mended for environmental compliance testing or similar activities.

The sensor can connect wirelessly via Bluetooth to a computing device such as a tablet or computer using PASCO data collection software (see www.pasco.com). The software supports data logging when the instrument is not connected to a computing device. The Wireless Colorimeter and Turbidity Sensor has a rechargeable battery pack.

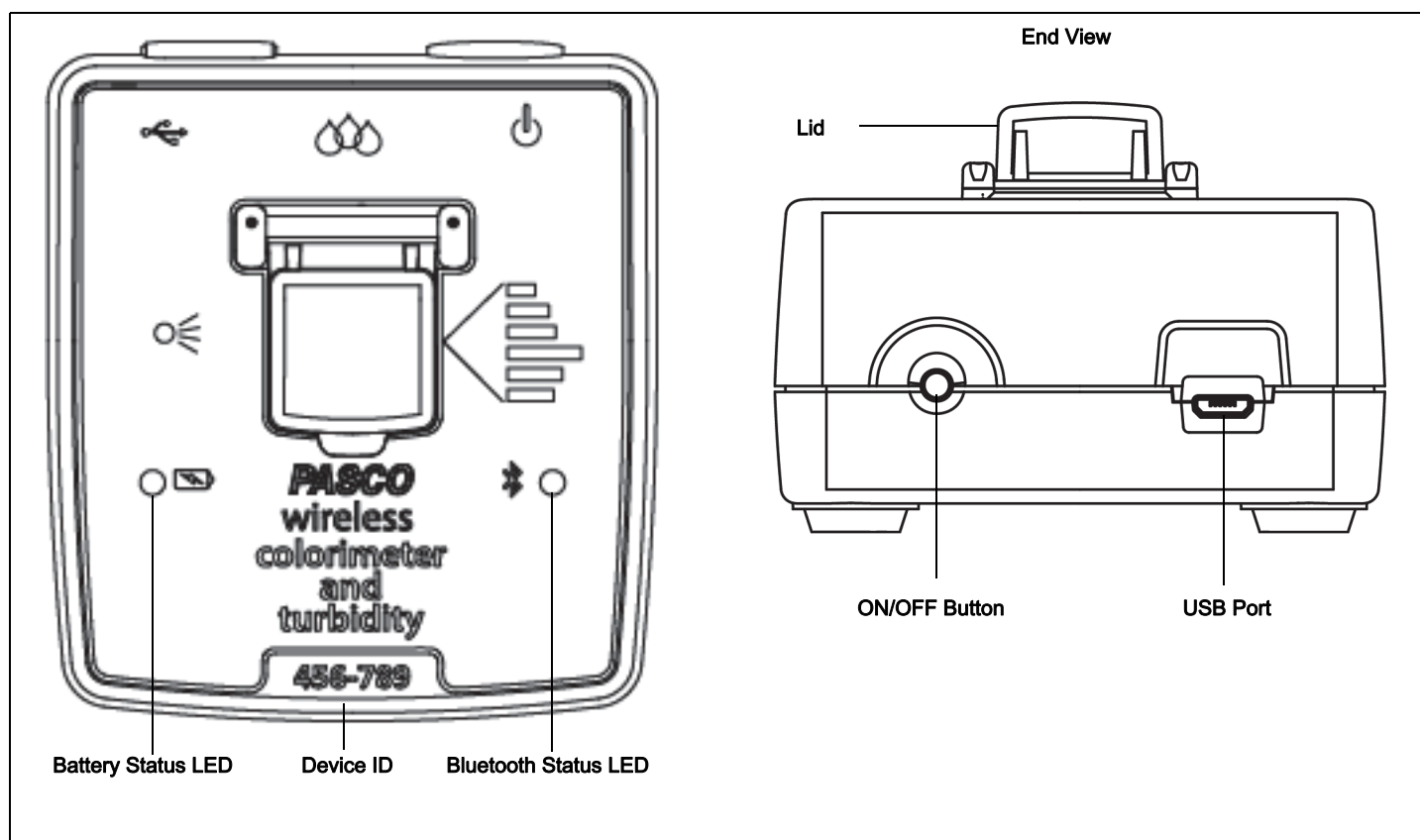

Operation

Charge the Battery

- **Connect the USB Cable:** Use the Micro USB Cable to connect the micro USB port on the back of the Wireless Colorimeter Sensor to a USB port on a USB charger (or a computing device).
- Charging begins automatically. The battery status LED shines yellow while the unit is charging, and will shine green when the battery is charged. The charger circuit inside the sensor turns itself off when the unit is fully charged. The battery is partially charged at the factory. Initial charging time may be three hours or longer.

Turn on the Sensor

Press the ON/OFF button. Both status LEDs will shine momentarily. If the battery is charged, the Battery status LED will stop shining. The Bluetooth status LED will continue to blink red. This indicates that the device is ready to connect wirelessly via Bluetooth to a computing device such as a computer or tablet.

To turn off the sensor, press and HOLD the ON/OFF button until the Battery status LED shines red momentarily.

Software Help

NOTE: See the SPARKvue Help or PASCO Capstone Help for information about collecting, displaying, and analyzing data.

- In SPARKvue, select the HELP button in any screen including the Home Screen.
- In PASCO Capstone, select PASCO Capstone Help from the Help menu, or press F1.

Connect the Sensor Wirelessly

Start the PASCO data collection software (such as PASCO Capstone or SPARKvue).

PASCO Capstone: Select “Hardware Setup” in the Tools palette. When the software detects the Wireless Colorimeter Sensor with Turbidity, the Bluetooth status LED on the sensor blinks green. In the Hardware Setup window, select the sensor that has a six-digit Device ID that matches the Device ID on the sensor itself. After searching, the software will display “Colorimeter” in Hardware Setup.

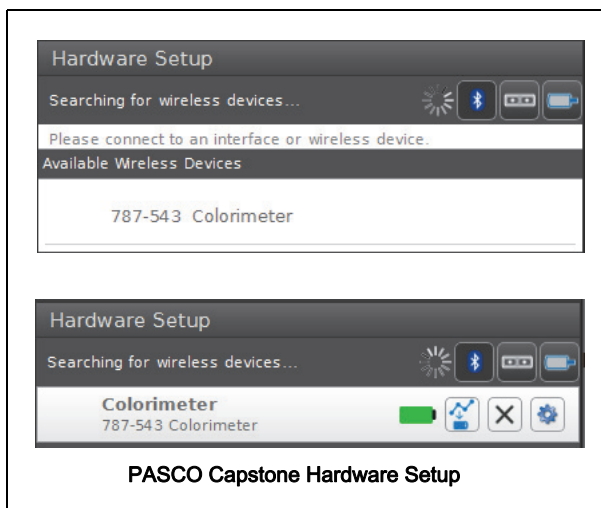

PASCO Capstone Hardware Setup

Select “Hardware Setup” again to close the Hardware Setup window.

in “Page #1”, drag a display or pick a QuickStart template in the main window.

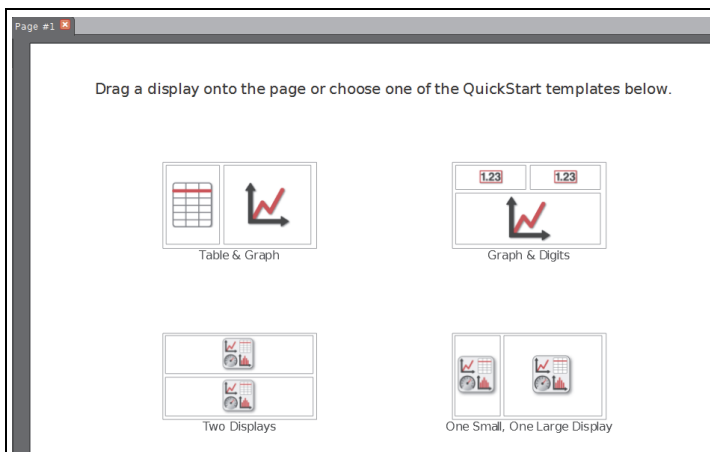

In the display, open a “Select Measurement” drop down menu. The menu shows the measurements that are possible with the sensor.

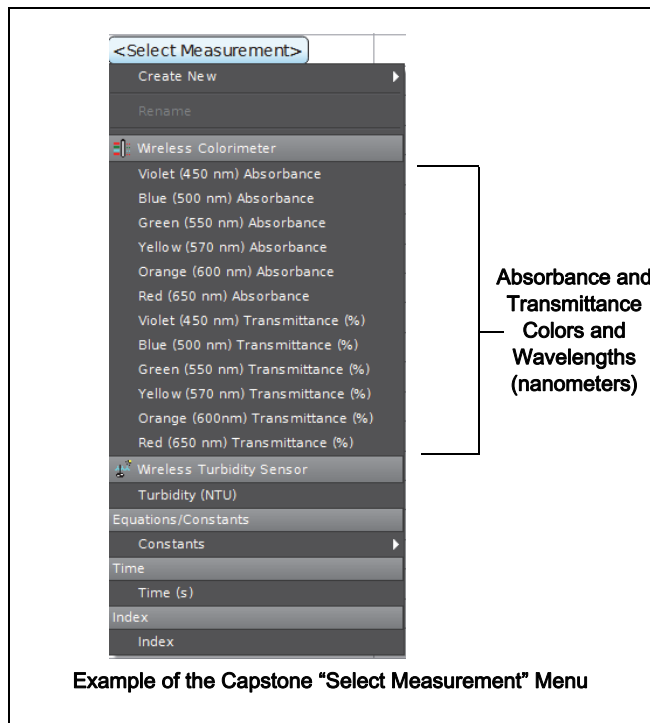

Example of the Capstone “Select Measurement” Menu

Make a choice from the drop down menu. The display will show the selected measurement versus time. Configure the display as needed.

SPARKvue: In the Home screen, select the “Bluetooth” icon at the top of the screen.

- The Wireless Devices window opens.

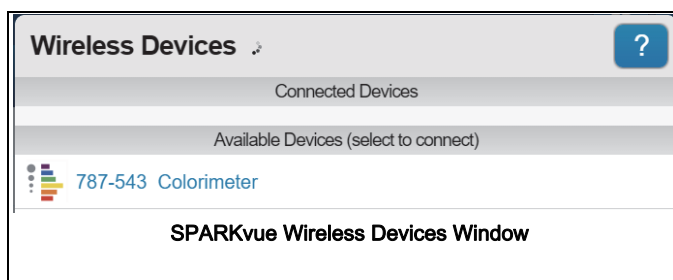

SPARKvue Wireless Devices Window

Select the “Available Device” that has the same six-digit Device ID as the one on the sensor. Select “Done” at the bottom of the window.

The SPARKvue Sensors window opens with a list of all the available measurements possible with the sensor.

Sensors		
Wireless Colorimeter ☑		
Violet (450 nm) Absorbance	0.000	📈
Blue (500 nm) Absorbance	0.155	📈
Green (550 nm) Absorbance	0.000	📈
Yellow (570 nm) Absorbance	0.000	📈
Orange (600 nm) Absorbance	0.060	📈
Red (650 nm) Absorbance	0.354	📈
Violet (450 nm) Transmittance	173.7 %	📈
Blue (500 nm) Transmittance	69.9 %	📈
Green (550 nm) Transmittance	103.5 %	📈
Yellow (570 nm) Transmittance	107.3 %	📈
Orange (600nm) Transmittance	87.4 %	📈
Red (650 nm) Transmittance	44.4 %	📈
Wireless Turbidity Sensor ☑		
Turbidity	102.2 NTU	📈

SPARKvue Sensors Window Measurement List

Select a measurement to automatically open a Graph display or select a QuickStart template.

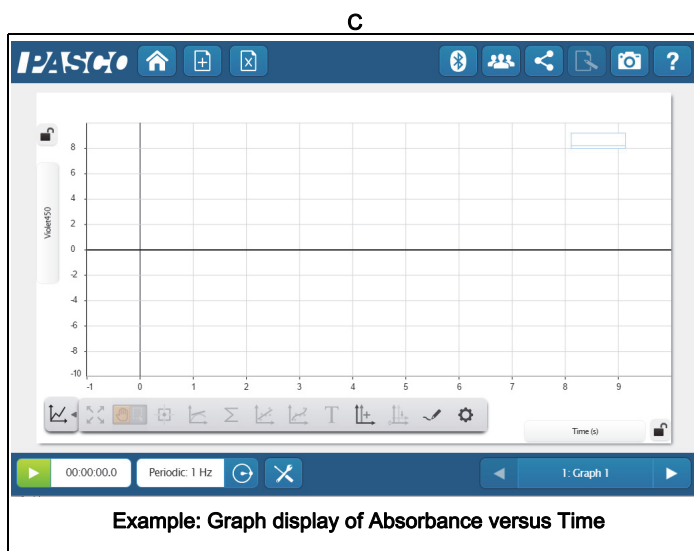

Calibration Preparation Procedure

Calibration is recommended before each experiment for better accuracy. Calibration is stored in the sensor. See Appendix A for an explanation of calibration procedures for colorimetry.

However, calibration is required the first time that turbidity is measured. It is also necessary when you are measuring solutions with varying temperatures, or when using different cuvettes. All calibrations are stored inside the sensor in flash memory.

Prepare a Turbidity Calibration Cuvette

The first part of the procedure is to make a “Calibration Cuvette”. This requires the 100 NTU Calibration Solution Bottle, one of the four-sided cuvettes, and the 100 NTU label with the expiration date.

Remove the lid from the four-sided cuvette. Carefully remove the cap of the Calibration Solution Bottle. Invert the bottle and hold the tip over the open cuvette. Squeeze the bottle to fill the cuvette approximately three-fourths full as shown below. Recap the bottle. Put the lid on the cuvette.

Put the 100 NTU label over the cuvette lid as shown.

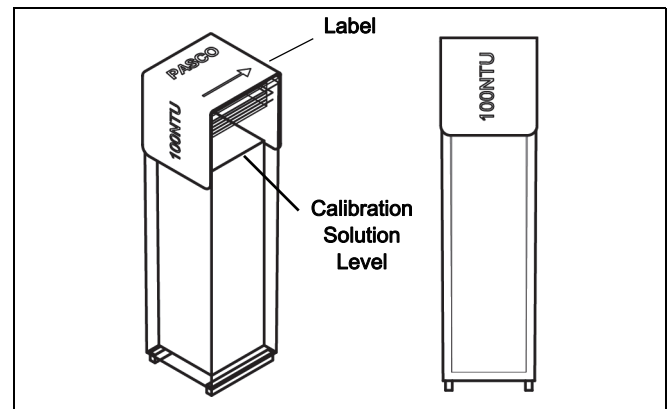

The direction arrow on the label indicates which way the calibration cuvette should be placed in the sensor. When placing the cuvette into the cuvette holder, make sure that the arrow points at the screw at the front edge of the holder.

Prepare a “Zero Standard” Cuvette

Fill another four-sided cuvette with deionized water to the same level as the solution in the calibration cuvette. This second cuvette will be used as the “zero” standard in a “two-point” calibration process.

Open the lid, put the cuvette with the deionized water into the cuvette holder, and close the lid.

Calibration

Follow the steps described in the PASCO data collection software to complete a “two-point” calibration for turbidity.

When calibration is complete, set up a Digits display, and start recording data. The Digits display should show approximately 100 NTU \pm 1 NTU.

Preparation for Intermittent Use

If the 100 NTU Calibration Cuvette is stored for more than a month, do the following before calibration.

1. Shake the cuvette vigorously for one minute to stir up the particles.
2. Allow the cuvette to stand undisturbed for five minutes to eliminate air bubbles.
3. Gently invert the cuvette five times.
4. Clean the outside of the cuvette.

Expiration

By following the preparation procedures, the 100 NTU Standard sample should provide accurate results (\pm 7%) up to the expiration data on the bottom of the Calibration Solution bottle. After the expiration date, PASCO cannot guarantee the stability of the sample.

Status LED Information

The Bluetooth and the Battery Status LEDs operate as follows depending on the type of connection:

For a connection to the USB Charger or a USB Port

Bluetooth	Status	Battery	Status
Red blink	Ready to pair	Yellow ON	Charging
Green blink	Connected	Green ON	Charged

For a wireless Bluetooth connection

Bluetooth	Status	Battery	Status
Red blink	Ready to pair	Red blink	Low power
Green blink	Connected		

Suggested Colorimetry Experiments

- Beer’s Law: find the relationship between the concentration and the absorbance of a solution. Use

this relationship to determine the concentration of an unknown sample.

- Reaction rate: measure changing absorbance over time as a chemical reaction occurs in the cuvette.
- Spectrum analysis: use the bar meter display to see a solution’s absorbance of all six colors. Compare different colored solutions.

Colorimetry Specifications

Range	0% to 100% transmittance 0 to 3 absorbance
Wavelengths (each with 40 nanometer FWHM)	450 nm (violet) 500nm (blue) 550 nm (green) 570 (yellow) 600 nm (orange) 650 nm (red)
Precision	\pm 0.03 absorbance units
Resolution	0.1% transmittance
Default sample rate	1 sample/s
Temperature range (for sensor and test sample)	5° C to 40° C (recommended)

Turbidity Specifications

Range	0 to 400 NTU*
Accuracy	5% for full range
Resolution	0.1 NTU
Temperature Range	5° C to 40° C

(*NTU = nephelometric turbidity units)

Battery Life

Battery Usage

Battery life is very important to making the sensor simple and always ready to use, so all of the PASCO wireless products are designed for long battery life. For example, the Wireless Colorimeter and Turbidity Sensor turns itself off after a brief time of inactivity to conserve battery life.

The battery life between charges for the Wireless Colorimeter Sensor ranges from one to four weeks or more.

If the battery status LED blinks red, connect the sensor to a USB Charger or to a USB port.

Maximizing Battery Life

One of the factors that affects battery life is the storage temperature. Therefore, avoid storing the Weather Source in very cold or very hot environments.

If the battery will not hold a charge, contact PASCO Technical Support.

Replacement Items

- Cuvettes and Caps (SE-8739) consists of 100 of the two-sided cuvettes and 100 cuvette lids.

Check with Technical Support regarding possible replacement items.

Technical Support

For assistance with any PASCO product, contact PASCO at:

Address: PASCO scientific
10101 Foothills Blvd.
Roseville, CA 95747-7100

Phone: 916-462-8384 (worldwide)
800-772-8700 (U.S)

Email: techsupp@pasco.com

Web: www.pasco.com/support

Limited Warranty

For a description of the product warranty, see the PASCO web site.

Copyright

This PASCO scientific *Reference Guide* is copyrighted with all rights reserved. Permission is granted to non-profit educational institutions for reproduction of any part of this manual, providing the reproductions are used only in their laboratories and classrooms, and are not sold for profit. Reproduction under any other circumstances, without the written consent of PASCO scientific, is prohibited. Rev: 12/17

Trademarks

PASCO, PASCO scientific, PASCO Capstone, PASPORT and SPARKvue are trademarks or registered trademarks of PASCO scientific, in the United States and/or in other countries. All other brands, products, or service names are or may be trademarks or service marks of, and are used to identify, products or services of, their respective owners. For more information visit www.pasco.com/legal.

Product End of Life Disposal Instructions:

This electronic product is subject to disposal and recycling regulations that vary by country and region. It is your responsibility to recycle your electronic equipment per your local environmental laws and regulations to ensure that it will be recycled in a manner that protects human health and the environment. To find out where you can drop off your waste equipment for recycling, please contact your local waste recycle/disposal service, or the place where you purchased the product.

The European Union WEEE (Waste Electronic and Electrical Equipment) symbol (to the right) and on the product or its packaging indicates that this product must not be disposed of in a standard waste container.



Battery Disposal Instructions:

Batteries contain chemicals that, if released, may affect the environment and human health. Batteries should be collected separately for recycling, and recycled at a local hazardous material disposal location adhering to your country and local government regulations. To find out where you can drop off your waste battery for recycling, please contact your local waste disposal service, or the product representative.

The Lithium Polymer (Li-Poly) rechargeable battery used in this product is marked with the International symbols to indicate the need for the separate collection and recycling of batteries.



Li-Poly

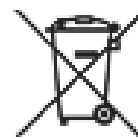

Appendix A

Theory of Calibration

One of the functions of the PASCO Data Collection Software is to take the stream of raw data from a sensor and transform it into the calibrated data that you see in the Graph, Table, and other displays. If you do not calibrate a sensor yourself, the software uses a default calibration that is loaded when the sensor is connected.

You can think of the software as taking in raw data and outputting calibrated data. When you perform a calibration, the software redefines the linear equation that transforms the raw input data into the calibrated output data. The linear function is of the form:

Raw Input = Slope x Calibrated Output + Offset

Or:

Calibrated Output = (Raw Input - Offset)/Slope

The function can be represented graphically as a line.

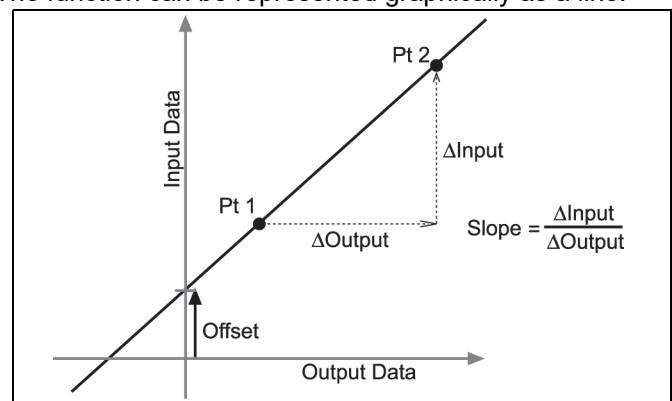

Two points, Pt 1 and Pt 2, define the line. In the two-point calibration procedure, each point is reset by associating a known standard value (for instance, the pH of a buffer solution) with a raw input measurement that the sensor sends to the GLX when it is in that standard. In a one-point calibration, only one of the points is reset by the user.

Types of Calibration

There are three types of calibration: two-point, one-point slope, and one-point offset. Any of these calibrations can be performed on a single sensor, or simultaneously on multiple similar sensors; however, for any given sensor, the software will automatically select the most typical calibration type as the default setting.

Two-Point

In a two-point calibration, you reset two points to define a new line. This type of calibration affects both the slope and the offset.

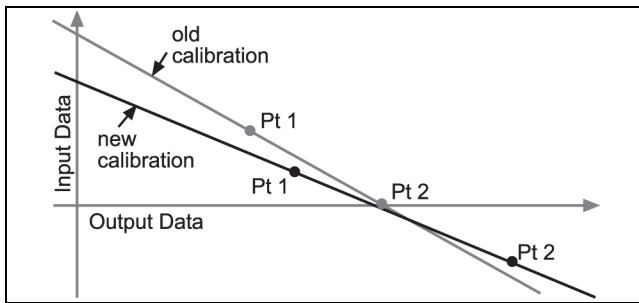

One-Point Slope

In a one-point slope calibration, you reset only one point. The slope of the line changes so that the line intersects the new point, while the offset (or Y-intercept) does not change.

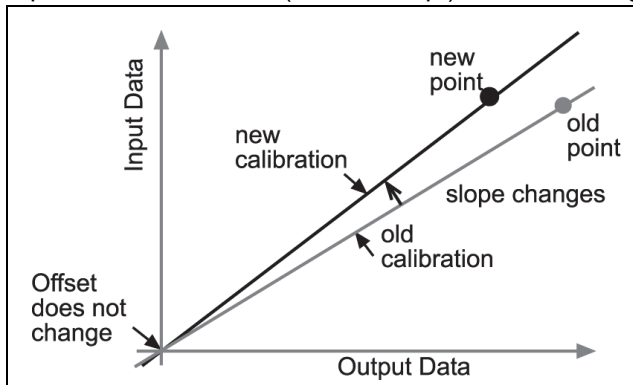

One-Point Offset

In a one-point offset calibration, you reset only one point. The line shifts so that it intersects the new point, but its slope does not change.

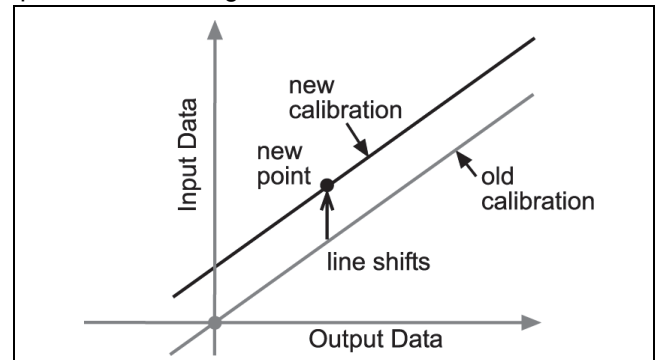

Offset calibration is usually used to make one sensor agree with another sensor. Due to normal variation among probes, a second probe might read consistently higher than the first probe. Normally this difference would be insignificant; however, an offset calibration can be used to bring the sensors into closer alignment.

Using PASCO Software for Calibration

NOTE: Check the on line Help System in SPARKvue or Capstone for the most up-to-date calibration information.